



1986

Tensile and Shear Bond Strengths of bis-GMA Adhesives to Cast Etched Alloy

James J. Koelbl
Loyola University Chicago

Follow this and additional works at: https://ecommons.luc.edu/luc_theses

 Part of the [Prosthodontics and Prosthodontology Commons](#)

Recommended Citation

Koelbl, James J., "Tensile and Shear Bond Strengths of bis-GMA Adhesives to Cast Etched Alloy" (1986). *Master's Theses*. 3415.

https://ecommons.luc.edu/luc_theses/3415

This Thesis is brought to you for free and open access by the Theses and Dissertations at Loyola eCommons. It has been accepted for inclusion in Master's Theses by an authorized administrator of Loyola eCommons. For more information, please contact ecommons@luc.edu.



This work is licensed under a [Creative Commons Attribution-Noncommercial-No Derivative Works 3.0 License](#).
Copyright © 1986 James J. Koelbl

TENSILE AND SHEAR BOND STRENGTHS
OF BIS-GMA ADHESIVES TO
CAST ETCHED ALLOY

BY

James J. Koelbl, D.D.S.

Library -- Loyola University Medical Center

A Thesis Submitted to the Faculty of the Graduate School
of Loyola University of Chicago in Partial Fulfillment
of the Requirements for the Degree of
Master of Science

May

1986

ACKNOWLEDGEMENTS

The author would like to thank the director of his thesis committee, Dr. James Sandrik, who has persevered through several false starts and a seemingly unending period of "Thesis Supervision." The author's gratitude extends also to the other members of the committee: Dr. Leon Laub, for his special talent at editing, and at paying attention to the details; and Dr. Martin Land, whose clinical expertise has proved invaluable.

Thanks also go to the members of the department of Operative Dentistry: to Dr. Al Vlazny, for his initial encouragement and support; for the other members of the department, who shouldered the load when this faculty member was off attending class or working in the laboratory. The author also wishes to offer special thanks to Dr. Peter Hasiakos, who provided the motivation to get this project off the ground, and whose tireless effort was invaluable in the design and construction of the experimental apparatus.

Credit also goes to Mr. Zakir Sabri, who manufactured much of the equipment used in the project, and whose ability to translate drawings and measurements into actual experimental devices was much appreciated.

Finally, the author wishes to thank his wife, Susan: and his sons, Chris, Sean, Ryan, and Kevin, the last two who weren't even born when this odyssey first began. Obviously, without their patience and understanding, an endeavor like this would have been impossible.

VITA

The author, James J. Koelbl, is the son of Joseph John Koelbl and Mary Agnes (Cronin) Koelbl. He was born December 16, 1948 in Evergreen Park, Illinois.

His elementary education was obtained at Our Lady Gate of Heaven in Chicago, Illinois. His secondary education was completed in 1966 at St. Ignatius High School, Chicago, Illinois.

In September, 1966, Dr. Koelbl entered John Carroll University in University Heights, Ohio. After completing pre dental requirements he entered the University of Illinois College of Dentistry, Chicago, Illinois, receiving the degree of Doctor of Dental Surgery in June, 1973.

In 1978 Dr. Koelbl joined the faculty at Loyola University School of Dentistry, Maywood, Illinois as Assistant Professor of Operative Dentistry. He has served Loyola as Assistant Director of Clinics, Director of the General Practice Residency in Dentistry, and Chairman, Department of Operative Dentistry. He was promoted to the rank of Associate Professor of Operative Dentistry in July, 1984, and was assigned to his current position of Assistant Dean for Admissions and Student Affairs in July, 1985.

Dr. Koelbl is a member of the American Dental Society, Illinois State Dental Society, Chicago Dental Society, American Association of Dental Schools, Pierre Fauchard Academy, and other professional organizations. In November, 1985, he was honored as a Fellow of the American College of Dentists.

TABLE OF CONTENTS

	PAGE
ACKNOWLEDGEMENTS	ii
VITA	iii
LIST OF TABLES	iv
LIST OF FIGURES.	v
Chapter	
I. INTRODUCTION.	1
II. REVIEW OF RELATED LITERATURE.	3
III. MATERIALS AND METHODS	13
IV. RESULTS	33
V. DISCUSSION.	40
BIBLIOGRAPHY	45

LIST OF TABLES

Table		Page
1.	Shear Test Data Obtained with Comspan and Conclude.	37
2.	Tensile Test Data Obtained with Comspan and Conclude	38
3.	Comparison of Bond Strengths for Litecast B.	39

LIST OF FIGURES

Figure	Page
1. Line Drawing of Posterior "Rochette" Type Bonded Bridge	6
2. Critical Thickness of Components of Maryland Bridge	7
3. Enamel Modification for Maryland Bridge	9
4. Photograph, Plastic Specimens on Sprue.	14
5. Photograph, Cast Alloy Specimen	15
6. Photograph, Holder Used in Finishing Cast Specimen.	16
7. Line Drawing of Etching Apparatus	18
8. SEM of Etched Alloy Surface	19
9. Photograph of Specimen Holder W/Specimen.	20
10. Line Drawing of Teflon Split-ring Mold in Place on Specimen	22
11. Photograph, One-half of Split-ring Mold	23
12. Photograph, Split-ring Mold in Place on Specimen	24
13. Photograph, Composite Disc Bonded to Face of Alloy Specimen.	25
14. Photograph, Specimen in Specimen Holder Attached to Lower Member of Instron	26
15. Line Drawing, Side View of Stainless Steel Ring on Sample.	27
16. Line Drawing, Frontal View of Stainless Steel Ring on Sample.	28

Figure	Page
17. Photograph, Two Specimen Holders with One-half Split-ring Mold.	30
18. Photograph, Two Specimen Holders with Entire Split-ring Mold.	31
19. Line Drawing of Tensile Test Apparatus.	32
20. Photograph, Example of Adhesive Failure	34
21. Photograph, Example of Adhesive-cohesive Failure	35
22. Photograph, Example of Cohesive Failure	36

CHAPTER I

INTRODUCTION

Historically in dentistry, missing teeth have been replaced by either a removable partial prosthesis or a conventional fixed partial prosthesis. An obvious drawback to the removable prosthesis is the fact that it is not cemented in place, but rather is an appliance that the patient must place and remove himself. In some clinical situations, the removable prosthesis is the only possible solution to the problem of replacing missing teeth in partially edentulous patients. Such a situation would be when there are no posterior abutments on which to build a fixed bridge.

In situations where support is more favorable, or when edentulous spans are shorter, a common form of treatment is the conventional fixed bridge. A properly constructed bridge of this sort is cemented in place, contributes to the maintenance of periodontal health, and restores a fully functioning occlusion to the patient. One drawback, though, is that construction of this type of bridge requires extensive preparation of the abutments, often requiring full crown restorations. This is not a concern when the abutment already requires a crown type restoration. However, in many situations construction of a fixed bridge requires preparation of a previously sound tooth. This is of special concern when treatment planning for the replacement of missing teeth for younger patients where pulpal anatomy may prohibit adequate tooth preparation.

With the advent of modern adhesive restorative dental materials,

much effort has gone into developing procedures for replacing missing teeth by using these materials. Most of these procedures involve little or no abutment tooth preparation, but their goal is to provide for the replacement of missing teeth with an appliance that is 'fixed' or cemented in the mouth. While the so-called bonded bridges have not yet proven to be as durable as conventional fixed bridges, they do have advantages in specific clinical situations. Their most common uses are as functional space maintainers in young patients, and as replacements for single missing teeth where both abutment teeth are not involved with caries or previous restorations.

However, bonded dental materials are being continuously improved, and researchers continue to try to find better methods to utilize these materials for the replacement of missing teeth in all types of patients.

In an earlier study, to be described in the Review of the Literature, Livaditis developed an apparatus to test the tensile strengths of the resin-cast alloy bonded systems. The apparatus was useful only for measuring tensile strength, and was estimated to be somewhat expensive to duplicate. In addition, Livaditis did not include shear strength measurements in his protocol, and in fact, most of the reported data on resin-cast alloy bonds includes only tensile data.

The purpose of the current study is to develop an apparatus that will measure both tensile and shear bond strengths consistently. In addition, this system will be used to compare the resin-cast alloy bond strengths of two commonly used resin cements.

CHAPTER II

REVIEW OF THE LITERATURE

In 1973, Rochette described a method for splinting mandibular anterior teeth by bonding a perforated cast metal framework to etched tooth enamel using unfilled acrylic resin. The framework was attached to the resin by undercut perforations in the metal, and the resin was bonded to the enamel of the teeth by means of the acid etch technique.

In 1975, Stolpa reported on two clinical cases in which he used the acid etch technique to replace missing anterior teeth by bonding an acrylic denture tooth to the enamel of the adjacent abutments. He used this resin bonded prosthesis as an intermediate, esthetic replacement in selected cases.

In 1978, Jordan et al. reported on data gathered from observations of 86 anterior temporary fixed prostheses that involved multiple incisor units. Acrylic resin teeth were bonded with and without pins to the abutment teeth by use of the acid-etch technique. Of 67 prostheses luted without pins, 75% remained securely in position from three months to one year or more. Of the total number, 10% were dislodged within a week or less after placement, and an additional 15% were dislodged within one to two months of placement.

Dislodgement of the pontics occurred almost always as a fracture within the bulk of the bonding resin. The authors concluded that the main

limitation of the technique was associated primarily with the inherent lack of strength of bonding resins relative to the functional demands of the oral environment.

Denehy and Howe went a step further and utilized the bonded, perforated cast framework to replace missing anterior teeth. They used a self-curing, filled composite resin system to attach the prosthesis to the abutment teeth. Their clinical technique did not involve any reduction of the abutments. Thus, in the replacement of maxillary anterior teeth, adequate lingual clearance to compensate for the thickness of the cast restoration was necessary. In addition, the potential for displacement was directly related to the incisal forces. The most favorable clinical situation for long-term success was the anterior open bite case. Cases reported at the time (1977) were observed for approximately 1-2 years. The authors considered the technique to be only temporary.

In 1980, Nathanson and Moin reported on the use of the acid-etch/composite resin technique and a metal reinforced pontic for the replacement of missing anterior teeth. Their criticism of the Denehy and Howe technique was twofold. First, since all of these bonded tooth restorations could only be considered at best a long-term temporary restoration, the cast metal to porcelain bridges were relatively expensive. Secondly, the metal framework of the Denehy/Howe bridge had to be fairly thick to prevent flexibility that might induce stress in the porcelain pontic. This created the potential for occlusal interference.

Nathanson and Moin formed their metal framework by welding rectangular, perforated orthodontic pads together. These pads are used in

orthodontics to bond brackets to tooth enamel. They fitted the metal frame to conform to the lingual surfaces of the abutment teeth, and then formed a pontic of composite over the metal frame. The entire structure was then attached to the enamel of the abutment teeth by the acid-etch/composite resin technique. The main advantage that the authors cite in favor of their technique versus the Denehy/Howe technique is that the former is less expensive and less time-consuming than the latter.

While various investigators studied the use of the resin-bonded acid-etch technique for splinting teeth, for replacing missing anterior teeth, and for providing long term fixed retention after orthodontic therapy, there is little information regarding the application of resin-bonded retainers on posterior teeth. In 1980, Livaditis reported a technique for the design, fabrication, and bonding of posterior resin-bonded retainers. He utilized a cast framework similar in design to the Rochette casting. Perforations were made in the occlusal rests and on the lingual plate area. These perforations were narrow on the tooth side and funnelled out away from the tooth to allow the composite bonding resin to lock onto the framework. (Figure 1)

Although Livaditis used gold alloy in this study, he recommended the use of non-noble alloys in the future. The increased rigidity of the non-noble alloy would allow for decreased thickness of the retainers. Thus, one of the drawbacks of the Denehy/Howe retainer could be minimized. (Figure 2)

Unlike Denehy and Howe, Livaditis did modify the abutment teeth which would anchor the prosthesis. Most of the reduction was directly

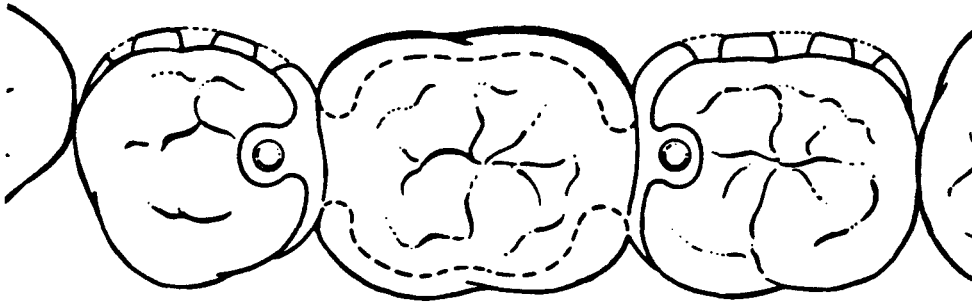

Figure 1.

Drawing of posterior "Rochette" type of bonded bridge.

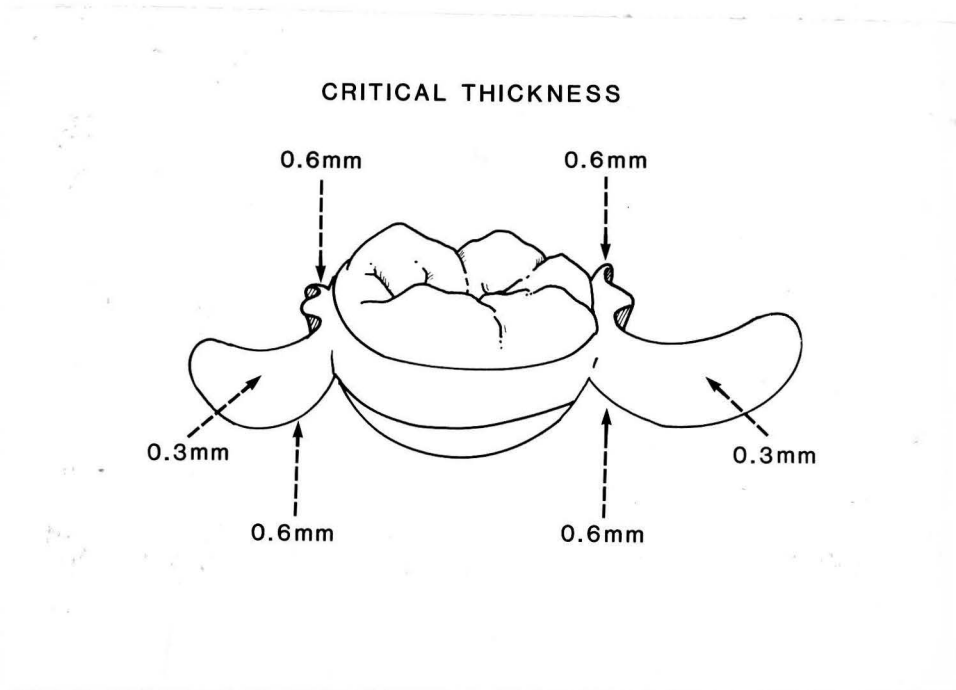

Figure 2.

Illustration, critical thickness of components of "Maryland" Bridge.

related to developing a path of insertion for the bridge. In all cases, the tooth modifications were limited to the enamel so that a proper resin-enamel bond could be assured. (Figure 3)

According to Livaditis, the bonding process is the most critical factor in the success of these retainers. He found the available resin materials to be inadequate. The size of the filler in conventional composite resins appeared to prevent the complete seating of the restoration. The microfilled resins provided no perceptible improvement. Livaditis felt that the optimum luting material would possess the favorable characteristics of a filled resin but with a film thickness of less than 25 microns. At the time, Livaditis used a composite resin developed specifically for resin-bonded retainers. In initial trials, he stated that this material significantly reduced the problem of film thickness. He cautioned, however, that additional research was needed to substantiate his early clinical impressions. This material, or the derivation of it, is one of the materials to be used in this study. In summary, Livaditis described the resin-bonded retainers as an alternative to conventional fixed prosthodontic retainers. In addition to having the qualities of a fixed appliance, these retainers enabled the procedure to be conservative, economical, and reversible.

In 1982, Livaditis and Thompson reported on a method for etching cast metal for the purpose of bonding the etched metal to composite resin. Based on the work previously reported by Tanaka et al., and by Dunn and Reisbick, Livaditis and Thompson developed a new etching technique for a specific non-noble nickel-chromium porcelain-to-metal alloy (Biobond C & B

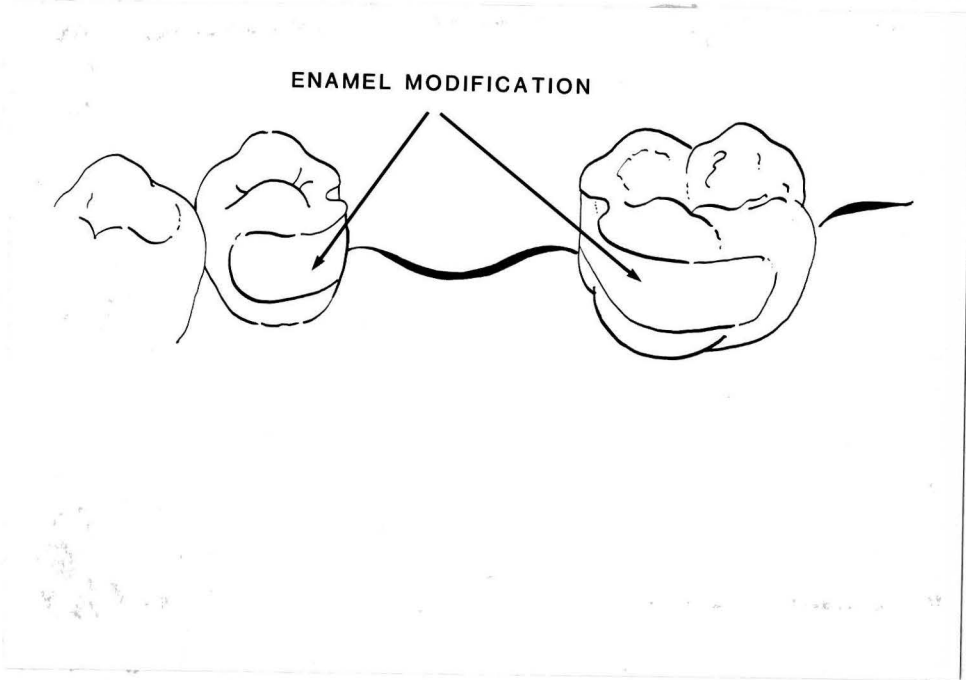

Figure 3.

Illustration, typical enamel modification for the construction of a 'Maryland' Bridge.

alloy, Dentsply, International, York, Pa.). Circular discs were cast so that the surface of the disk to be etched was 1.0 cm². The surface to be etched was polished with 600 grit paper to provide a uniform and known surface. All exposed metal surfaces of the disk except the area to be etched were covered with wax. Various agents at various concentrations were tried as electrolytic solutions. The current was varied for each solution, and the length of time for the etching was varied from 1 to 25 minutes. Etched surfaces were evaluated by visible light stereo microscopy (10-40X), SEM photomicrographs (200-2000X), and through tensile testing of a resin rod bonded to the etched metal surface.

In 1983, Thompson, Del Castillo, and Livaditis reported in detail on their technique for electrolytically etching cast metal for the purpose of being bonded to composite. The stated purpose of the research was to discover a convenient method of electrolytically etching non-precious alloys and to determine the strength of the bond of dental resins to the etched surface. Discs 6.5mm in diameter and 1.0mm thick were cast, subjected to a porcelain firing cycle, and mounted on an electrode. The as-cast faces of the specimens were air abraded with 50 μ alumina and then water washed. All parts of the electrode and the discs except the face to be etched were masked with sticky wax. Various etching solutions and etching times were evaluated. From visual and SEM observation, those etching conditions that gave retentive-appearing surfaces were selected for tensile bond testing.

The bonding procedure consisted of washing each etched disc with methyl isobutyl ketone, air-drying, and then placing the disc on the rubber alignment pad of a special bond alignment apparatus. A self-curing

unfilled resin bonding agent (L.D. Caulk Co.) was applied to the etched surface by brush. Composite resin (Comspan, L.D. Caulk Co.) mixed at the time of mixing the bonding agent was packed into a knife-edged beveled stainless steel tube. The tube was placed in the upper member of the alignment apparatus and the upper member was moved along the aligning rods until the beveled tube contacted and aligned the etched alloy disc on the rubber pad in the apparatus base. Contact was maintained with finger pressure and the plunger inserted through the hole in the upper member and pushed through to make contact with the setting resin. The force on the plunger was maintained at approximately 2.0 kg/cm^2 . The entire operation was completed within 90 seconds after the beginning of the mix. Five minutes after the mix was begun, the sample with the tube and its internal resin column were removed from the alignment apparatus and immersed in a 37°C water bath. All samples were then thermally cycled between 5°C and 60°C in water baths for a minimum of 1,000 cycles.

Tensile testing of the resin-to-alloy bond was performed in an apparatus which was based on the method of Standlee et al. A collet was used to hold the stainless steel tube in the upper member. The upper member was connected through a universal joint to the load cell of the universal testing machine. Tensile testing was done at a constant strain rate of 1.0 mm/min .

Biobond C&B alloy was found to yield the most consistent and visually retentive surface when 0.5N nitric acid was used with a current density of 250 mA/cm for five minutes. Etching of Rexillum III with 10% sulfuric acid at 300mA/cm for three minutes resulted in an etched surface that gave

excellent bonding. Tensile testing of the resin to metal bonds gave values of 27.3 MPa for Biobond and up to 26.1 MPa for Rexillum III. The Biobond samples were not subjected to porcelain firing cycles prior to etching, while all Rexillum samples were so conditioned. In summary, Lividatis reported that nonprecious Ni-Cr casting alloys could be electrolytically etched to yield a highly retentive surface for micromechanical bonding of dental resins. Conditions for etching are specific for each alloy. The tensile strengths for the resin-alloy systems for Bioband C&B and Rexillum III was determined to be almost two times the accepted value of the resin bond to acid-etched enamel (~ 14 MPa). Considering the conservative clinical techniques for the fabrication of the etched metal fixed prostheses, this ability to bond would provide an excellent alternative to the conventional fixed partial prosthesis.

One of the difficulties of the Livaditis experiment was the apparatus developed to test the tensile strengths of the resin bonded systems. The apparatus was useful only to measure tensile strengths, and estimated to be somewhat expensive to duplicate. The purpose of the current study is to develop an apparatus which can be manufactured inexpensively, and which will measure both tensile and shear bond strengths consistently.

CHAPTER III

MATERIALS AND METHODS

Interfacial testing in shear and in tension was performed between a nickel-chromium alloy, Litecast B (Williams Gold Refining Co., Buffalo, New York) and two composite cements, Comspan (Caulk Co., Milford, Delaware), and Conclude (3M Co., St. Paul, Minnesota).

Specimen Preparation

Acrylic patterns, 6.0 mm in diameter and 12.0 mm in length, with a hole drilled at 5.0 mm from one face, were prepared from Plexiglas rod. (Figure 4) A phosphate-bonded investment was used (Hi-Temp, Whip Mix Co., Louisville, Kentucky). The alloy was melted with a propane-oxygen gas mixture, and cast centrifugally. (Figure 5)

Any specimens with voids, bubbles, or other imperfections on the face to be etched were discarded. Any blebs on the lateral surfaces were carefully removed. All new alloy was used for each casting. Specimens were placed in a holder so that the face would remain perpendicular to the long axis of the cylinder during fine grinding through 600 grit SiC paper. (Figure 6) Water was used as a lubricant during the finishing process, and the specimens were rinsed with ethanol after finishing.

Specimens were etched according to the alloy manufacturer's instructions. Using a Micromet Etcher (Model 70-1740, Buehler Co., Lake Bluff, Illinois), a current density of 200 mA/cm² was maintained for six minutes

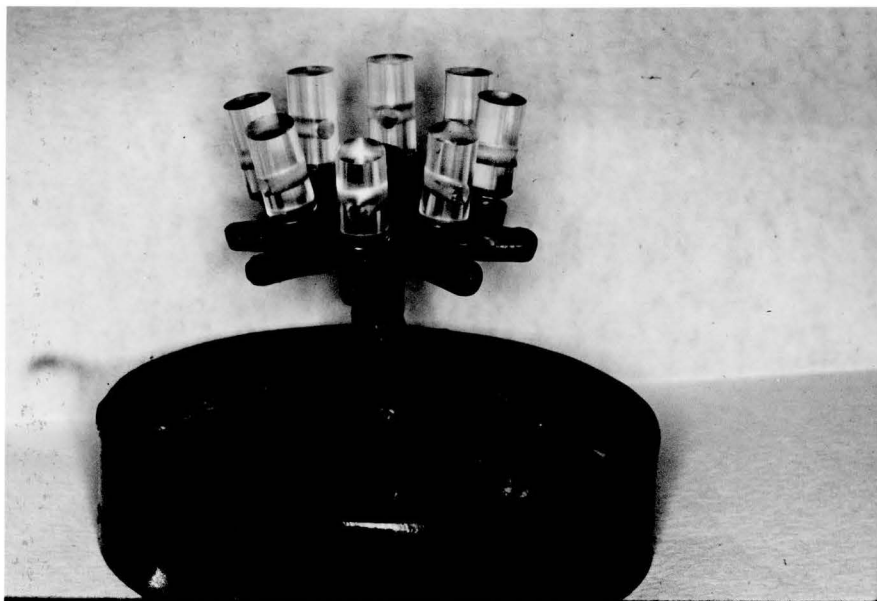

Figure 4.

Plastic specimens on sprue prior to investing and casting.

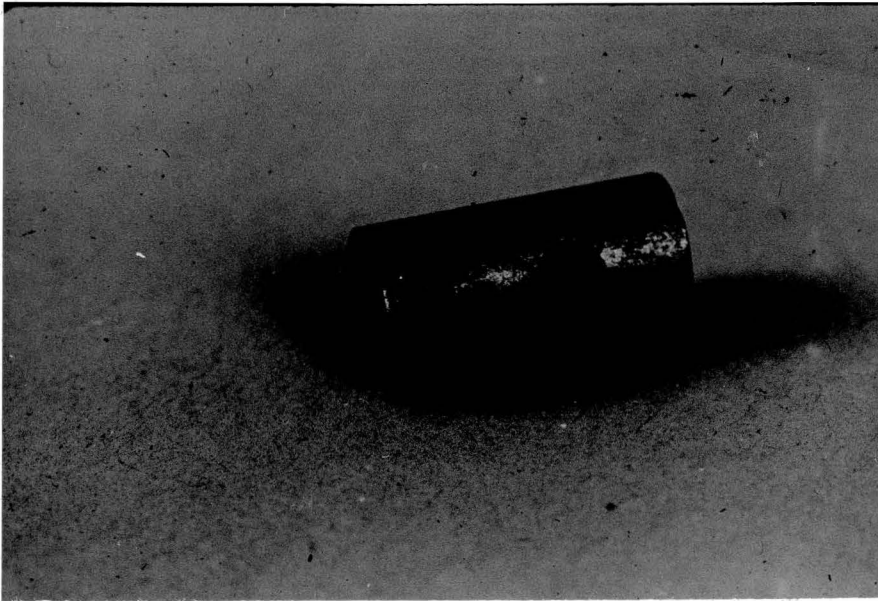

Figure 5.

Cast alloy specimen.

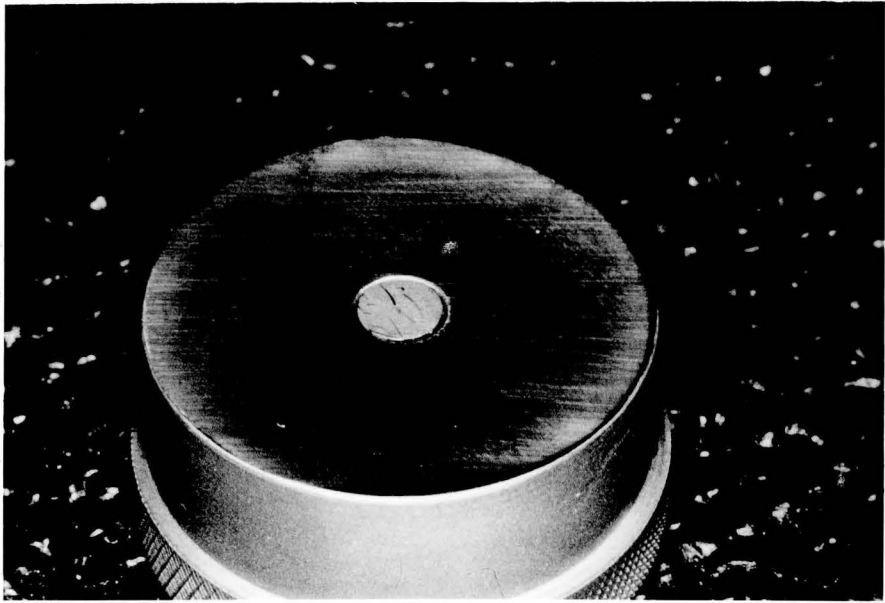

Figure 6.

Stainless steel holder used in finishing face
of cast alloy specimen.

in an electrolyte consisting of nine parts 10% sulfuric acid and one part absolute methanol. The etching apparatus is depicted in Figure 7. The cathode was a section of 0.072" diameter A.I.S.I. type 302 stainless steel rod bent at an angle of 90 degrees. Sticky wax was placed around the circumference of the cylinder to isolate the surface to be etched. The specimen surface, which served as the anode, was positioned perpendicular to the cathode at a distance of 1.0 to 1.5 cm. Use of a magnetic stirrer reduced the accumulation of bubbles on the surface to be etched. After etching, the specimen was rinsed with water, then agitated in 18% hydrochloric acid for 10 minutes in an ultrasonic cleaner. The specimen was again rinsed with water, air dried, then chilled in ice water to facilitate removal of the sticky wax from the periphery.

To ensure that the surfaces were properly etched, selected specimens were viewed under a scanning electron microscope. In addition, all specimens were viewed under a metallographic microscope at 100X and 400X magnifications. An example of a typical etched surface is shown in Figure 8.

Shear Testing

A specimen holder was designed to facilitate forming the composite/alloy interface and to align the sample in a universal testing machine. The stainless steel (A.I.S.I. type 303) holder, 12mm in diameter by 3cm long, includes a hole which is slightly larger than the specimen diameter. (Figure 9) The test specimen was secured by a retaining pin which passes through the holder and the hole in the test specimen, then tightened by a set screw. The end of the specimen extends 2 mm beyond the holder. (Figure 9)

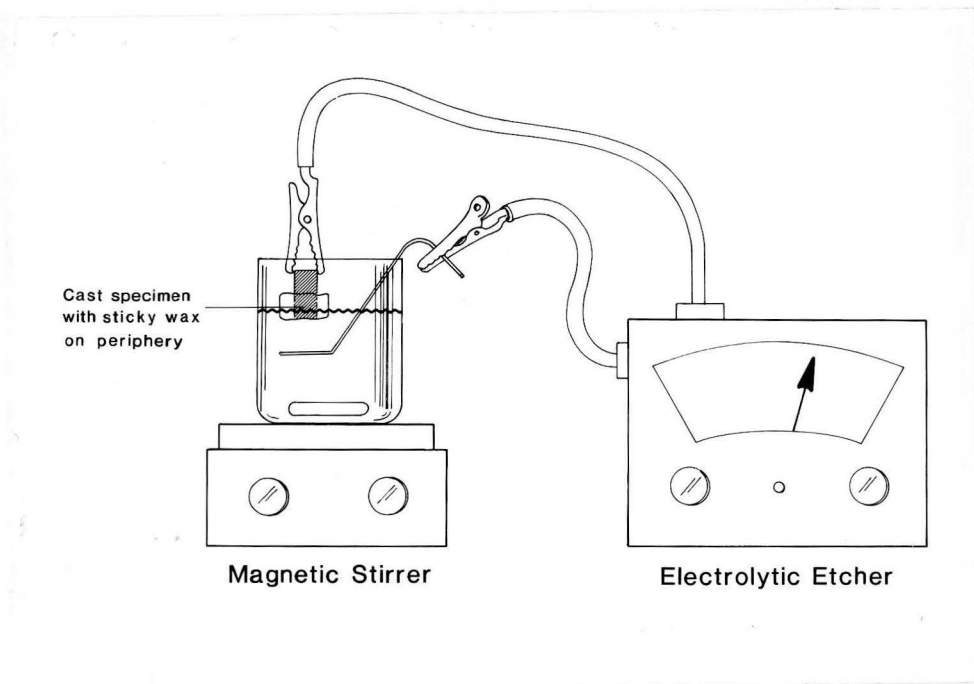

Figure 7.

Illustration of etching apparatus.

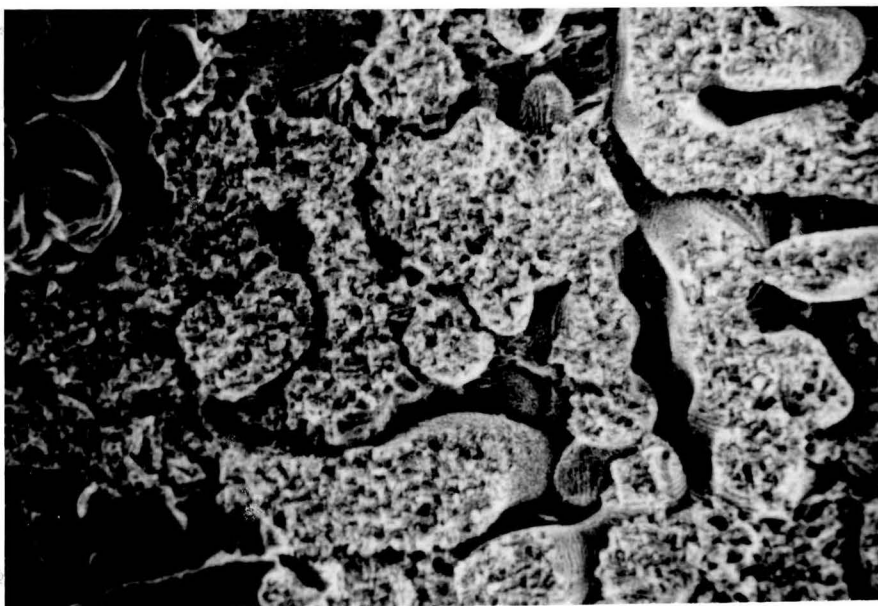

Figure 8.

Scanning Electron Microscope photograph of etched alloy surface (x 4,000) of cast alloy specimen.

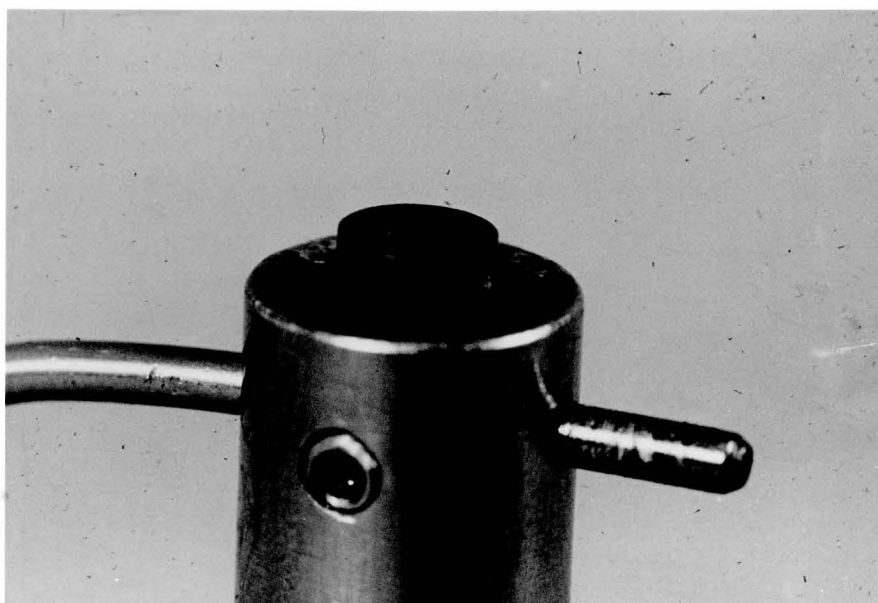

Figure 9.

Specimen holder with cast alloy specimen in place.

A Teflon mold, consisting of a split ring with an outer retaining ring, is placed over the specimen. (Figures 10, 11, 12) The mold has a 6.0 mm inside diameter to prevent flash from forming around the circumference of the alloy specimen. The composite cements are then mixed and placed according to manufacturers' instructions. After the composite sets the Teflon mold is removed, producing an interfacial bonded surface which is perpendicular to the long axis of the test specimen. (Figure 13)

A fixture, designed to secure the sample holder in the lower member of a universal testing machine (Model 1130, Instron Corp., Canton, MA.) by means of a retaining pin, was constructed from A.I.S.I. type 303 stainless steel. (Figure 14) The fixture positions the composite-alloy interface parallel to an applied load, which is the configuration needed to test the shear strength of the bond.

The alloy-composite interface is accurately placed 2.0 mm from the face of the fixture. (Figure 15) Force is applied through a freely hanging stainless steel ring, 3.0 mm thick with a knife edge at its center. (Figure 16) By using a 1.0 mm thick shim, the knife edge is predictably and consistently placed 0.5 mm from the alloy-composite interface. The ring is attached to the upper member of the universal testing machine by means of a chain, which allows for self alignment. Twelve specimens of each metal-composite combination were tested at 8 minutes from the start of composite mixing until failure occurred, using a strain rate of 0.5 mm/min (0.02 in/min).

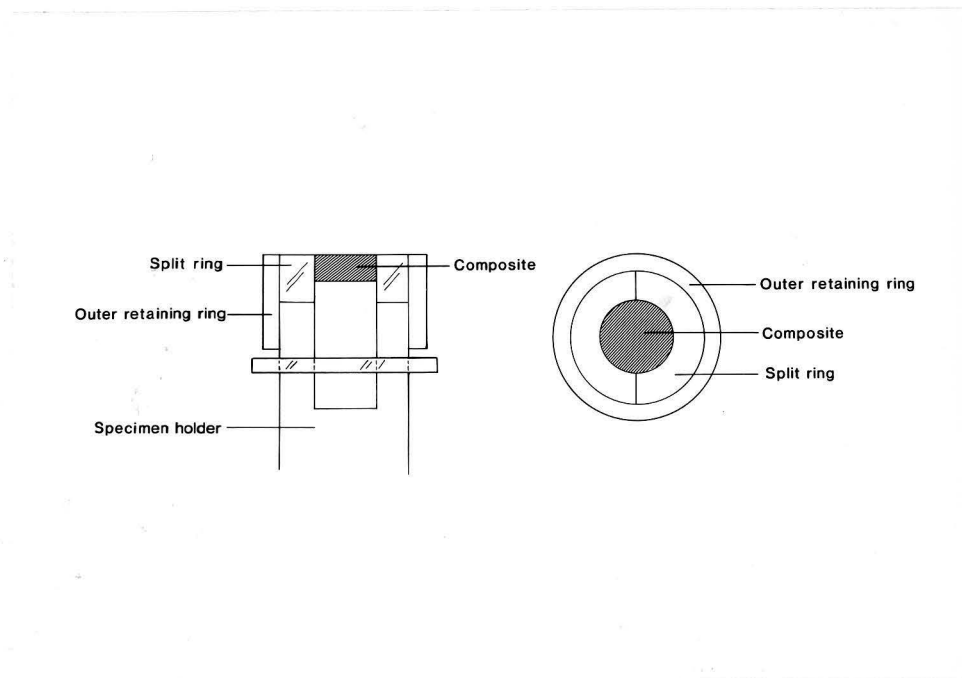

Figure 10.

Illustration of Teflon® split-ring mold in place on specimen.

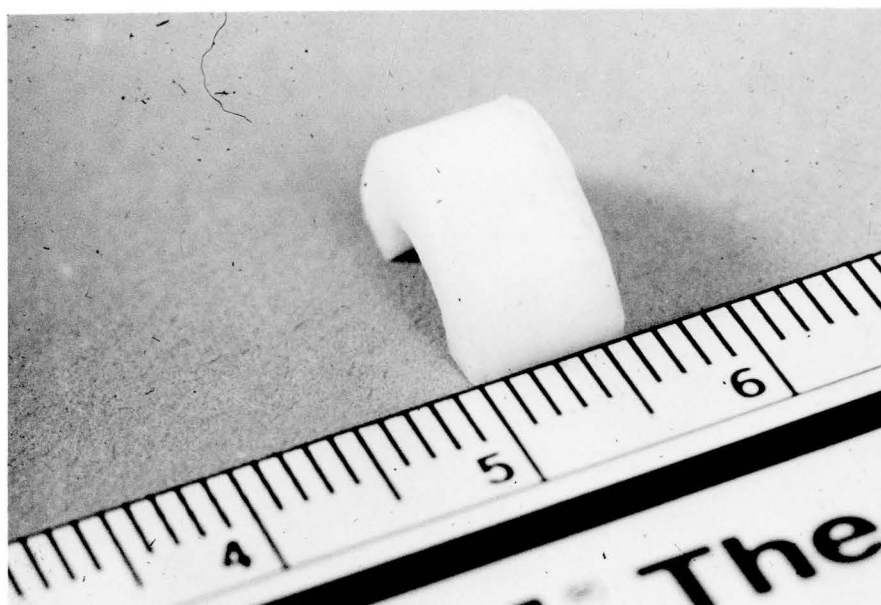

Figure 11.

One half of split-ring Teflon® mold

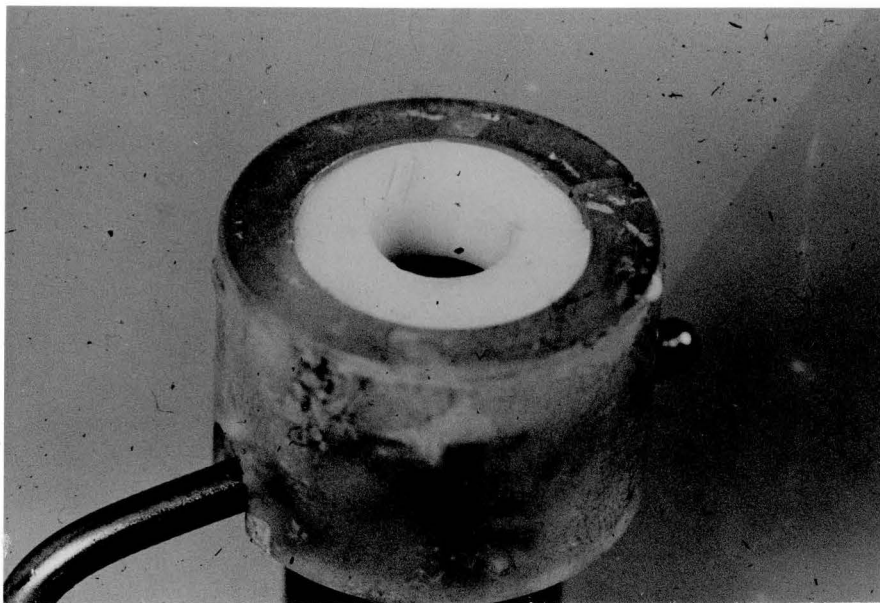

Figure 12.

Entire Teflon® split-ring mold in place on
cast alloy specimen.

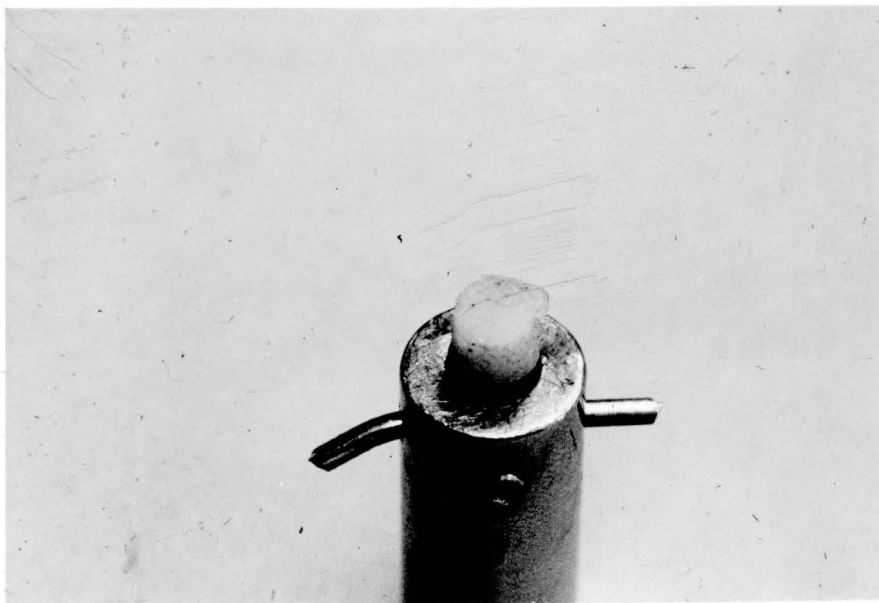

Figure 13.

Disc of composite luting agent bonded to face of cast alloy specimen.

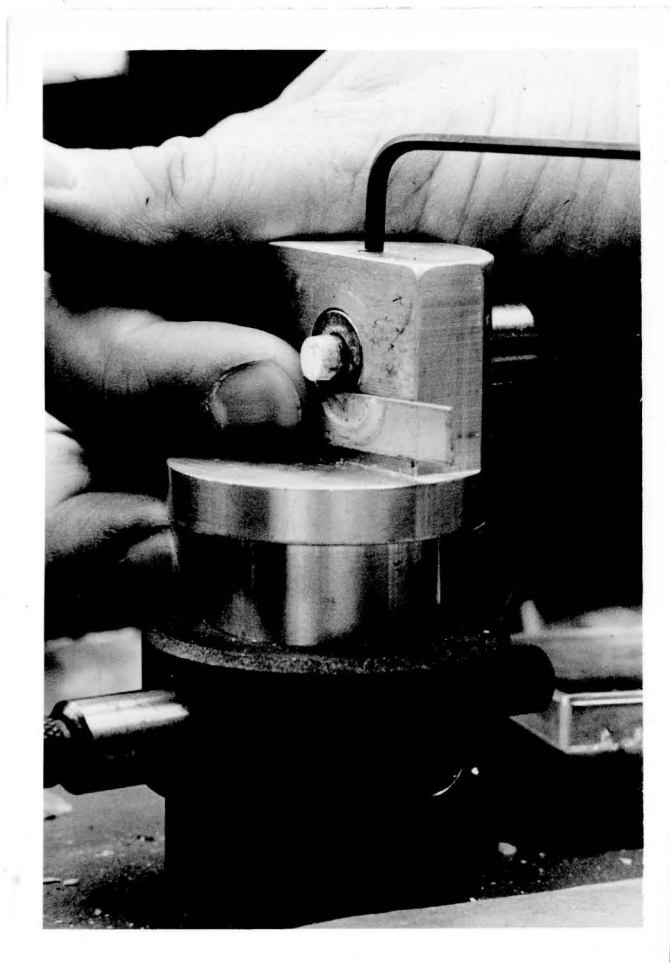

Figure 14.

Cast specimen in specimen holder attached to lower member of Instron testing machine.

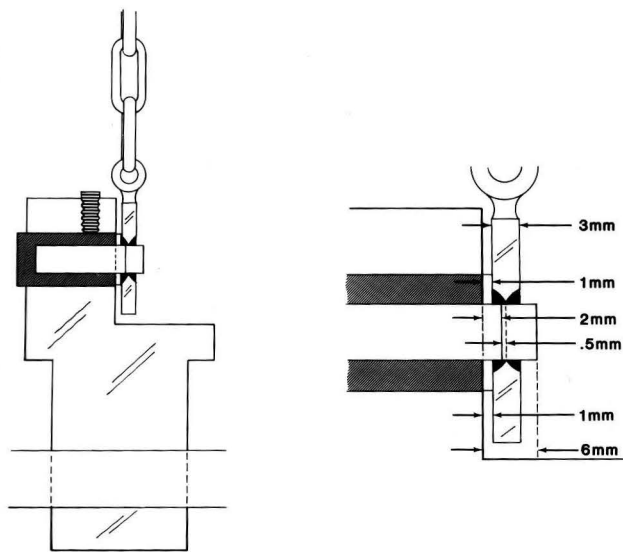

Figure 15.

Illustration, side view of stainless steel ring in place prior to shear testing.

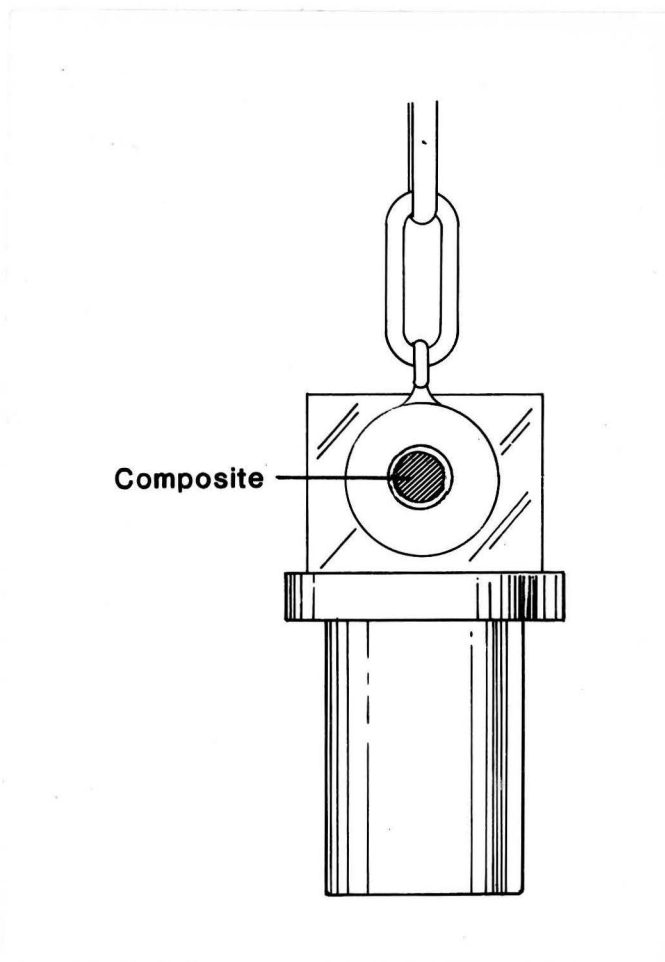

Figure 16.

Illustration, front view of stainless steel ring in place prior to shear testing.

Tensile Testing

Tensile test specimens were prepared by placing composite cement between the etched faces of two alloy samples. Each of a pair of alloy samples was placed in a holder, as described above, and positioned 2.0 mm apart using the split Teflon ring. (Figures 17, 18) The volume of composite needed to fill the space between the faces of the samples (6.0 mm in diameter by 2.0 mm thick) was inserted. Finger pressure held the ring together until the composite cured.

One sample holder was mounted firmly to the lower member of the universal testing machine by a retaining pin. The other holder was attached to the upper member of the universal testing machine by means of a freely hanging chain which assured vertical alignment. (Figure 19) The test configuration was then loaded in tension with generation of tensile forces perpendicular to the etched metal/composite interface.

Twelve samples of each metal/composite combination were tested at 8 minutes from the start of composite mixing until failure occurred, using a strain rate of 0.5 mm/min (0.02 in/min).

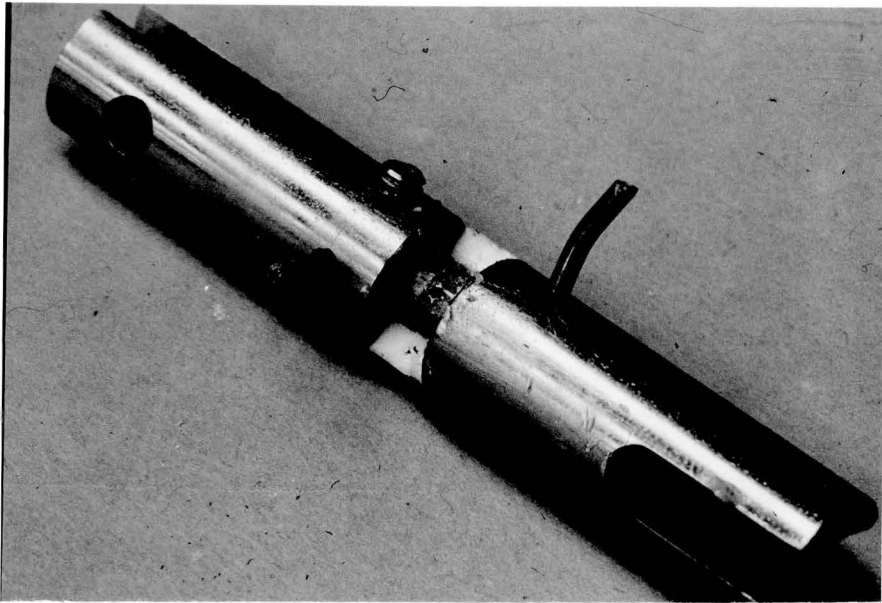

Figure 17.

Tensile test set-up: two specimen holders with one half of split-ring mold in place prior to placement of composite.

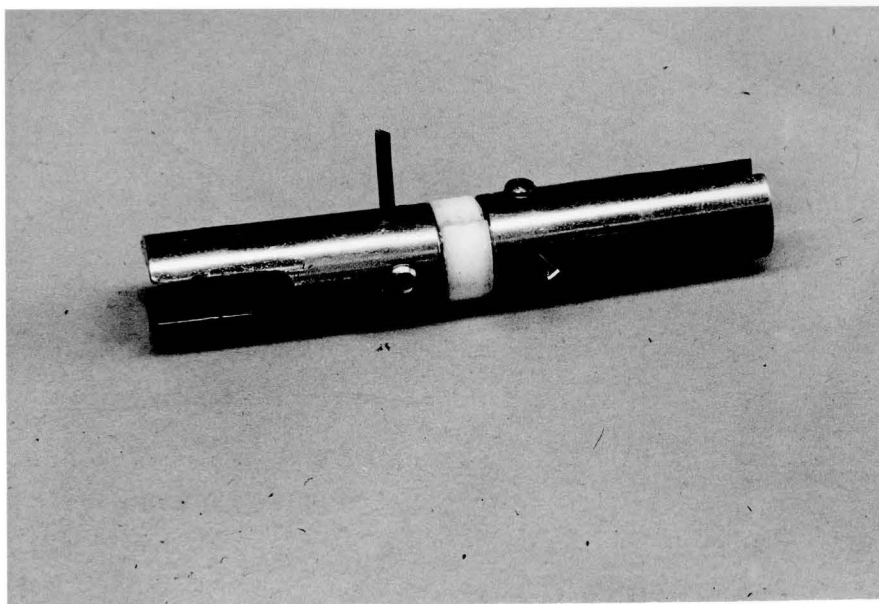

Figure 18.

Tensile test set-up: two specimen holders with entire split-ring mold in place while composite sets.

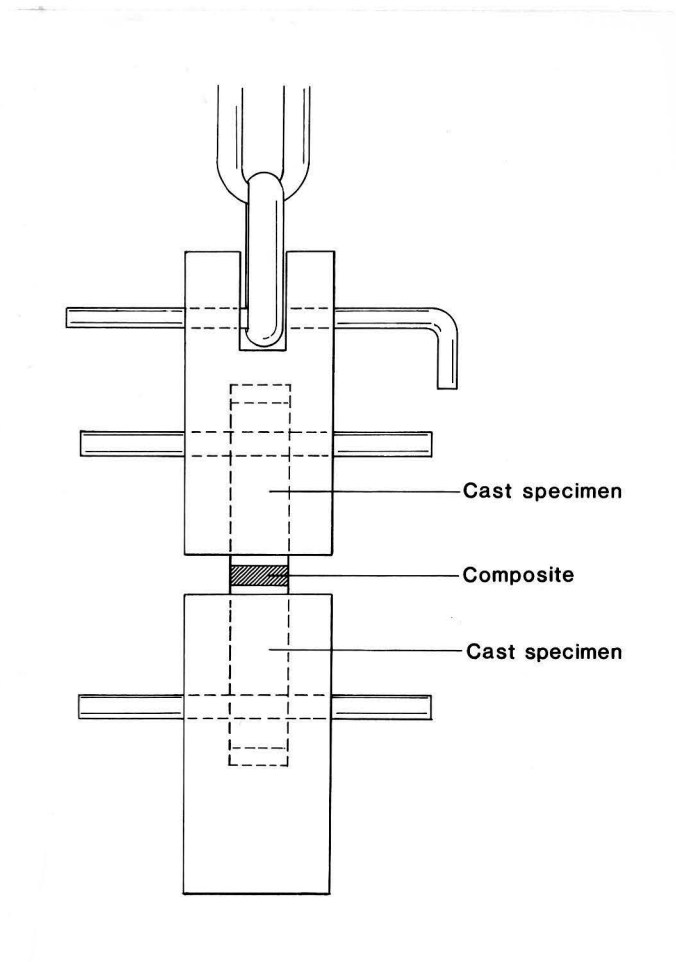

Figure 19.

Illustration, tensile test apparatus.

CHAPTER IV

RESULTS

Bond strength is determined as the load to cause failure of the test specimen divided by the interfacial cross-sectional area. Three modes of failure were observed: adhesive failure at the composite-alloy interface, cohesive failure through the composite, and mixed adhesive-cohesive failure. (Figures 20, 21, 22)

The mean value (12 specimens) of interfacial strength in shear for Comspan/Litecast B is 6.63 ± 0.94 MPa (961 ± 137 psi), and for Conclude/Litecast B is 5.55 ± 1.91 MPa (805 ± 277 psi). There is no significant difference ($p \leq 0.05$) between the two composite/alloy combinations.

The mean value (12 specimens) of interfacial strength in tension for Comspan/Litecast B is 6.97 ± 2.19 MPa (1010 ± 318 psi) and for Conclude/Litecast B is 8.32 ± 2.38 MPa (1207 ± 345 psi). There is no significant difference ($p \leq 0.05$) between the two composite/alloy combinations.

Table 1 lists the values obtained for shear bond strength of Litecast B to Comspan and Conclude. Table 2 lists the values obtained for tensile bond strength of Litecast B to Comspan and Conclude. Table 3 summarizes the mean values of all samples tested in shear and in tension.

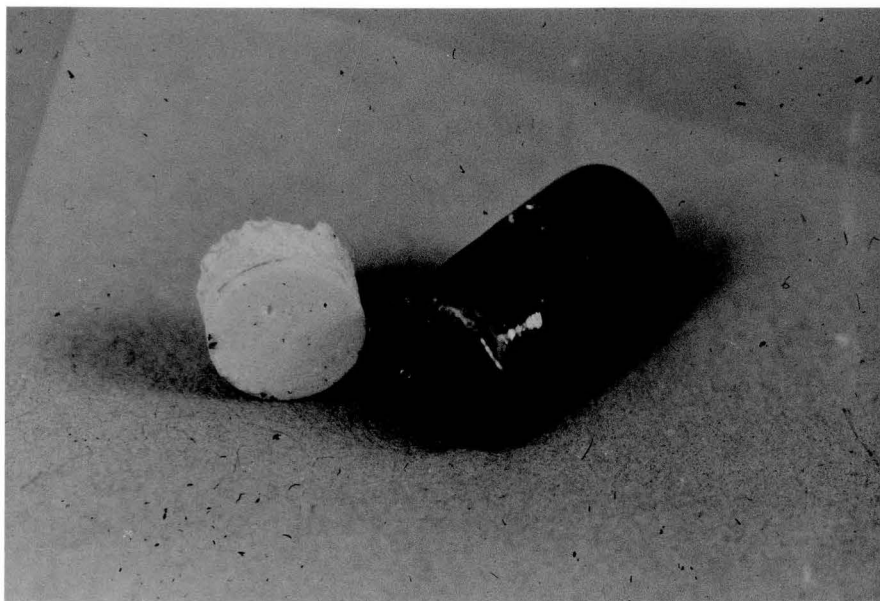

Figure 20.

Example of tensile adhesive failure.

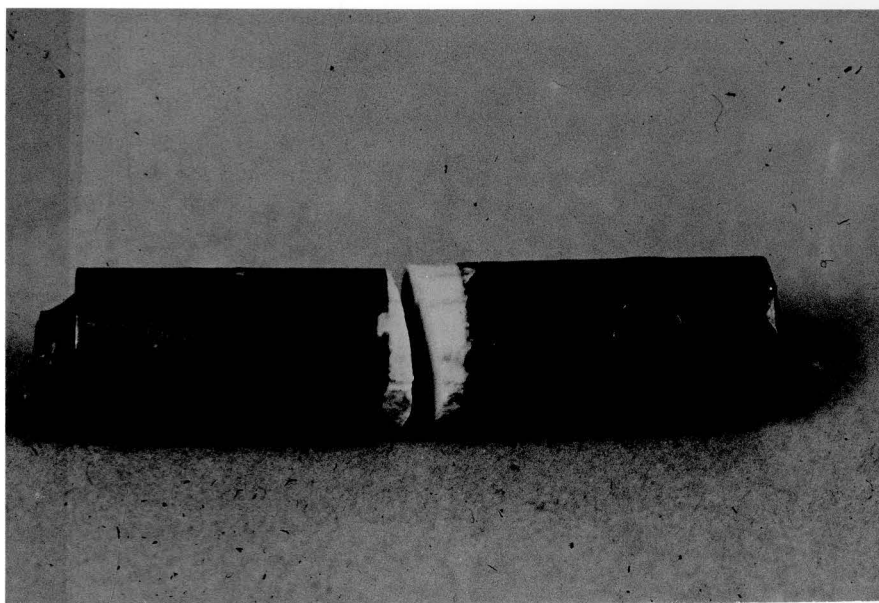

Figure 21.

Example of tensile adhesive/cohesive failure.

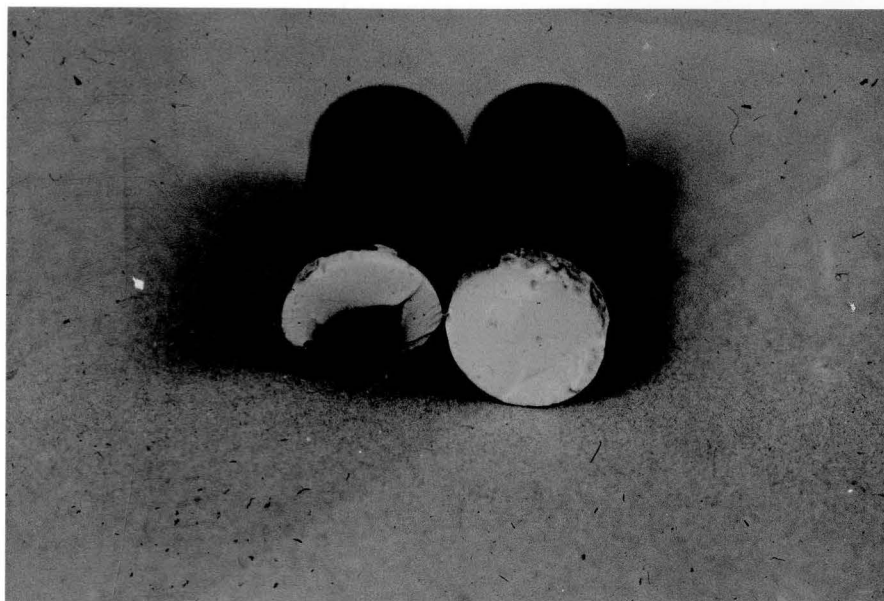

Figure 22.

Example of tensile cohesive failure.

TABLE 1

Shear Bond Strength of Litecast B to Resin Cement		
Sample Number	Resin Cement	
	Comspan (psi)	Conclude (psi)
1	926	806
2	666	696
3	1,080	501
4	1,060	348
5	906	732
6	1,270	664
7	890	1,281
8	906	927
9	915	550
10	1,030	944
11	963	892
12	925	1,316

TABLE 2

Tensile Bond Strength of Litecast B to Resin Cement		
Sample Number	Resin Cement	
	Comspan (psi)	Conclude (psi)
1	1,098	778
2	641	732
3	1,694	1,098
4	1,419	1,671
5	907	1,098
6	572	806
7	961	1,212
8	801	938
9	870	1,602
10	824	1,638
11	961	1,562
12	1,372	1,094

TABLE 3

SUMMARY		
Bond Strengths of Litecast B to Resin Cements		
	$\bar{X} \pm S$ in psi (N=12) [MPa]	
	Comspan	Conclude
Shear	961 \pm 137 [6.63 \pm 0.94]	805 \pm 277 [5.55 \pm 1.91]
Tensile	1,010 \pm 318 [6.97 \pm 2.19]	1,207 \pm 345 [8.32 \pm 2.38]

CHAPTER V

DISCUSSION

The so-called "Maryland" bridge includes both a resin/etched alloy bond and a resin/etched enamel bond. For such an appliance to be successful clinically the resin/etched alloy bond should have an interfacial bond strength greater than that of the resin/etched enamel bond. Then the bond at the composite-tooth interface would be the limiting factor in the success of such an appliance. Clinical restorations are subject to shear, tensile, and compressive forces, usually in a combination of these. In this study interfacial strengths were measured in shear and in tension.

Several designs for interfacial testing in tension were evaluated before the current test configuration was finalized. In each design the composite/etched metal interface was attached to the lower member of the Instron through the special specimen holder described earlier. The problem was to attach the composite to the upper member of the Instron so that tension could be applied to the bonded interface.

In an early design, a commercially available 360° fishing line swivel was imbedded into the composite during setting. This allowed the sample to be aligned in a universal testing machine through a chain attachment to the swivel. When load was applied initially, the chart on the universal testing machine registered a straight line increase of the load. However, at a load of approximately 45 psi, visual deformation of the swivel was noticed.

This corresponded to a definite interruption of the straight line graph. At a load of approximately 75 psi the swivel pulled completely apart. At this point in loading the composite sample was still intact. Thus, this particular design proved to be simply a test for measuring the strength of the swivel.

In another design, a casting was made in a nickel-chrome alloy. The casting had a small head on one end and a hole on the other end. The cast head was imbedded into the composite before initial set, and the hole was used to attach the chain that was fixed to the upper member of the Instron. However, when load was applied to the system, failure consistently occurred at the interface between the composite and the cast head of the attachment device. Consequently, the load at failure was not a measure of composite/etched metal interface. For the tensile test configuration reported in this study, composite was bonded between two etched metal cylinders. Attachment to the universal testing machine occurred through the metal and not the composite, reducing the non-axial loading of the bonded interfaces.

Thompson et al (1983, 1985) determined tensile bond strengths using two configurations: composite bonded to a single alloy specimen, and composite bonded between a pair of alloy specimens. Although the details of alloy preparation are not reported by Thompson with the study of Comspan-Litecast B interfacial tensile testing, it is assumed that the following protocol was used: subjecting the alloy to simulated oxidation and porcelain firing cycles, and air abrading the cast alloy surface with 50 micron alumina particles. Thompson developed the etching conditions: electrolyte, current density, and etching time for Litecast B.

Composite-bonded-to-alloy specimens were thermally cycled (1000 cycles between 5 - 50°C), and at an unspecified time after the initial composite mixing, were loaded until failure at a strain rate of 1.0 mm/min. A tensile bond strength of 32.4 ± 7.0 MPa (4700 ± 1020 psi) between Comspan and Litecast B was reported. Several parameters differed in the present study from the conditions described above which do not permit a direct comparison of tensile bond strength values. These differences include: test configuration, alloy surface roughness, alloy conditioning prior to the application of composite, thermal cycling, time of testing after applying the composite, and strain rate. Van Thompson sandblasted the metal surface with 50 micron alumina prior to applying composite cement. In this study the metal surface was finished using 600 grit silicon carbide metallurgical paper. The sandblasted surface should be rougher, permitting greater mechanical retention of composite. In both studies, composite was placed between pairs of etched metal specimens. However, the thickness of composite layer differed. Van Thompson used a thin film, 60 microns, compared with the 2.0 mm (20,000 micron) thickness used in this study. A thin film should result in a stronger interfacial bond. The strain rate used in loading test specimens also differed. Van Thompson used a strain rate of 2.0 mm/min compared to 0.05 in/min (0.5 mm/min) used in the present study. In the current study the alloy specimens were not thermally cycled prior to loading nor were they subjected to a simulated sequence of porcelain firing cycles. Specimens were tested at eight minutes from the start of composite mixing.

These test conditions may tend to give an apparently low value for tensile bond strength due to: 1) a relatively smooth and uniform alloy

surface which minimizes potential mechanical retention, 2) a relatively thick layer of cement compared to a clinical situation where a cement should have a film thickness less than 25 microns, 3) testing at a time interval which is consistent with the manufacturers' directions for clinical placement of an appliance, but before the diametral tensile strength of the composite has reached its greatest value, and 4) testing at a low strain rate.

For the thickness of cement used in this study, complex stress distributions may be generated through the cement layer when the specimen is loaded in tension. Regions of high stress concentrations may result in failure at low applied loads. In future work, a more clinically significant film thickness can be achieved by eliminating use of the split ring when preparing tensile specimens. Diametral tensile test results performed at 8 minutes after mixing at 23°C show values approximately 50% lower than for tests performed after the samples were stored for 24 hours at 37°C. A small number of samples (n=3) were tested at eight minutes and at twenty-four hours. The eight minute tensile values for Comspan averaged 19.5 ± 2.98 MPa (2830 ± 432 psi); the 24 hour values averaged 40.1 ± 1.49 MPa (5810 ± 216 psi). The eight minute tensile values for Conclude averaged 27.3 ± 5.60 MPa (3960 ± 812 psi); the 24 hour values averaged 50.6 ± 5.54 MPa (7340 ± 803 psi).

Conclusion: The results of the study indicate that the variability of the data is within acceptable limits. There was no significant difference at the $p \leq .05$ level between samples tested for each material in shear and tensile modes. The method developed for testing bond strengths

in the shear and tensile modes yields reasonably consistent results. However, several design changes must be made in the methodology in order to improve the reliability of the values obtained. The consistency of the etched metal surface is a variable, and a future study will utilize an improved etching system. For the tensile test, a method will be utilized in order to ensure an extremely thin layer of composite between the faces of the cast metal specimens. The specimens will be subjected to porcelain firing cycles and the bonded specimens will be more thoroughly tested both at eight minutes from the start of mixing and at 24 hours after submersion in a 37°C water bath.

BIBLIOGRAPHY

- Anderson, D.J.: Measurement of Stress in Mastication, *J. Dent. Res.*, 35:664-673, 1956.
- Baran, G.R.: Phase Changes in Base-Metal Alloys Along Metal-Porcelain Interfaces, *J. Dent. Res.*, 58:2095-2104, 1979.
- Buonocore, M.G.: A Simple Method of Increasing the Adhesion of Acrylic Filling Materials to Enamel Surfaces, *J. Dent. Res.*, 35:849, Dec., 1955.
- Chapman, E.W.: and Hamilton, M.L.: Maintenance of Diastemas by a Cast Lingual Loop Connector and Acid-Etch Technique, *JADA*, 104:49-50, 1982.
- Dennison, J.B.; and Craig, R.G.: Characterization of Enamel Surfaces Prepared With Commercial and Experimental Etchants, *JADA*, 97(5): 799-805, 1978.
- Dunn, B.; and Reisbick, N.H.: Adherence of Ceramic Castings on Chromium Cobalt Structures, *J. Dent. Res.*, 55:328-332, 1976.
- Howe, D.F., et al.: Anterior Fixed Partial Dentures Utilizing the Acid-Etch Technique and a Cast Metal Framework, *J. Prosth. Dent.*, 37(1):28-31, Jan., 1977.
- Jordan, R.E.; and Suzuki, M.: Temporary Fixed Partial Dentures Fabricated By Means of the Acid-Etch Resin Technique: A Report of 86 Cases Followed, *JADA*, 96(6):994-1001, 1978.
- Lambert, P.M.; Moore, D.L.; and Elletson, H.H.: In Vitro Retentive Strength of Fixed Bridges Constructed With Acrylic Pontics and an Ultraviolet Light Polymerized Resin, *JADA*, 92(4): 740-743, 1976.
- Laswell, H.R.; Welk, D.A.; and Regenos, J.W.: Attachment of Resin Restorations to Acid Preterated Enamel, *JADA*, 82:558-563, 1971.
- Lewis, A.J.: The Mechanisms of Tensile Failure in a Nickel-Base Casting Alloy, *J. Dent. Res.*, 56:631-634, 1977.
- Livaditis, G.J.; and Thompson, V.P.: Etched Castings: An Improved Retentive Mechanism for Resin Bonded Retainers, *J. Prosth. Dent.*, 47:1, 1982.
- Livaditis, G.J.: Cast Metal Resin-Bonded Retainers for Posterior Teeth, *JADA*, 101(6): 926-929, 1980.

- McLaughlin, G.: The Etched Metal Bridge: A New Laboratory Technique, Dental Laboratory Review, March, 1982.
- McLaughlin, G.: Composite Bonding of Etched Metal Anterior Splints, Compendium of Continuing Education, 2(5):279-283, 1981.
- Nathanson, D., et al.: Metal Reinforced Anterior Tooth Replacement Using Acid-Etch Composite Resin Technique, J. Prosth. Dent., 43(4): 408-412, Apr., 1980.
- Reinhardt, J.W.; Denehy, G.E.; and Chan, K.C.: Acid Etch Bonded Cast Orthodontic Retainers, Am. J. Orthodont., 75(2):138-142, 1979.
- Rochette, A.L.: Attachment of a Splint to Enamel of Lower Anterior Teeth: J. Prosth. Dent., 30:418-423, 1973.
- Standlee, J.P., Caputo, A.A., and Hanson, E.C.: Retention of Endodontic Dowels: Effects of Cement, Dowel Length, Diameter, and Design. J. Prosthet. Dent., 39:401, 1978.
- Stopla, J.B.: An Adhesive Technique for Small Anterior Fixed Partial Dentures, J. Prosth. Dent., 34:513, 1975.
- Sweeney, E.J.; and Moore, D.L.: Retentive Strength of Acid-Etched Anterior Fixed Partial Dentures: An In-Vitro Comparison of Attachment Techniques, JADA, 100(2):198-202, 1980.
- Tanaka, T.; Atsutz, M.; Uchiyama, Y.; and Kawashima, I.: Pitting Corrosion for Retaining Acrylic Resin Facings. J. Prosth. Dent. 42:282-291, 1979.
- Wei, S.: Electron Microprobe Analysis of the Remineralization of Enamel, J. Dent. Res., 49:621-625, 1970.
- Yanover, L.; Croft, W.; and Pulver, F.: The Acid-Etched Fixed Prosthesis. JADA, 104:325-328, 1982.

APPROVAL SHEET

The thesis submitted by James J. Koelbl, D.D.S. has been read and approved by the following committee:

Dr. James L. Sandrik, Director
Professor and Chairman, Dental Materials
Loyola University School of Dentistry

Dr. Leon W. Laub
Professor, Dental Materials
Loyola University School of Dentistry

Dr. Martin F. Land
Associate Professor and Chairman,
Fixed Prosthodontics
Loyola University School of Dentistry

The final copies have been examined by the director of the thesis and the signature which appears below verifies the fact that any necessary changes have been incorporated and that the thesis is now given final approval by the Committee with reference to content and form.

The thesis is therefore accepted in partial fulfillment of the requirements for the degree of Master of Science.

April 9, 1986
Date

James L. Sandrik
Director's Signature